

## Pilot Operated Proportional Reducing Valve

Model: DRE/DREM...6XJ



- ◆ Size 10/25
- ◆ Maximum working pressure 315bar
- ◆ Maximum working flow 300 L/min

### Contents

|   |           |
|---|-----------|
| Function description, sectional drawing | 02-03     |
| Functional symbols                      | 03        |
| Models and specifications               | <b>04</b> |
| Technical parameters                    | 05-06     |
| Characteristic curve                    | 06-07     |
| Component size                          | 08-09     |

### Features

- Maximum pressure protection, optional
- Optional check valve for freely flow of oil in reverse direction
- For subplate mounting
- For installation in manifolds
- Both valves and proportional amplifiers from the same supplier

Any part of this brochure can not be reproduced, edited, copied and disseminated electronically in any way without authorization of Jiayite Hydraulics company. As the product is in constant development and innovation, the information in this brochure is not specific to the special conditions or applicability of a specific industry, thus Jiayite Hydraulics company is not responsible for any incomplete or inaccurate description generated.



## Function description, sectional drawing

The DRE (M) valve is a pilot operated pressure reducing valve, it is used to reduce working pressure. The valve mainly consists of pilot valve (1) with proportional solenoids (2), main valve (3) with a main spool insert (4), and an optional check valve (5).

### Model DRE

The pressure at port A acts on the surface (7) of the main spool via throttle (6). The pilot oil flows from port B through the throttle (8) to the constant flow controller (9) which can keep the pilot flow constant away from the pressure drop between port A and B. The pilot oil flows from the constant flow controller (9) to the spring chamber (10), via throttles (11 and 12) and valve seat (13) to port Y(14, 15, 16) and from there to the tank. The pressure required in port A is controlled by the relevant amplifier. The proportional solenoid pushes the conical valve (20) towards the valve seat (13) to limit the pressure of the spring chamber (10) to the setting value. If the pressure at Port A is lower than the setting value, the pressure difference in the spring chamber (10) pushes the main spool to the right, thereby the connection from Port B to Port A is opened.

When the required pressure in port A is achieved, the force at the main spool is balanced and the main spool is maintained in the working position.

The pressure in port A  $X$  spool area (7) = spring chamber (10) pressure  $X$  spool area - spring force (17). If the pressure built up by the pressure liquid column (e.g. cylinder piston to stop) at port A is to be reduced, it need to adjust a lower command value in the relevant amplifier, and then the lower pressure will be built up in the spring chamber (10).

The higher pressure at port A acts on the face (7) of the main spool and pushes the main spool towards the plug (18). The connection from A to B is closed but A to Y is opened. The force of the spring (17) is used to balance the hydraulic pressure acting on the face (7) of the main spool. At this main spool position, the oil flows from port A to port Y through the control edge (19) into the return pipeline.

When the pressure at port A reduces to the pressure of the spring chamber (10) plus the pressure difference  $\Delta p$  on the spring (17), the main spool at the control edge A to Y closes the large control bores in the socket. The remaining pressure difference about 10 bar for the set pressure at port A can only be unloaded by control channel (21), thus it can achieve a perfect transient response performance without pressure sudden changes.

To ensure the fluid flows freely from port A to port B, a check valve (5) can be selected. Parts of the oil from port A will flow into port Y through the control edge (19) of the main valve spool into the return pipeline.

### Model DREM

To prevent the unexpected increase of the control current due to the proportional solenoid, which cause an increase in pressure at port A and may affect the safety of the hydraulic system, it can optionally to install a spring-loaded pressure relief valve as maximum pressure limitation (22) for maximum pressure protection of the system.

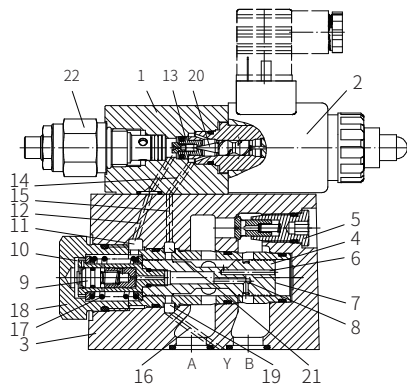

Model DREM- 6XJ/ YG24K24 (with check valve)

## Function description, sectional drawing

### Model DRE (M) E (with integrated amplifier)

The function and design of this type valve is exactly the same as the DRE (M) valve if without integrated amplifier. The amplifier is located in the connector (23), and supplies power and receives the command value voltage by plug-in type (24). The set value - pressure characteristic curve is pre-set by the manufacturer based on the principle of minimum manufacturing tolerance.

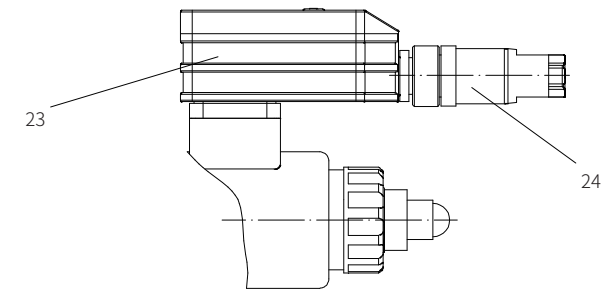

## Functional symbols

DRE...-6XJ/...YM...

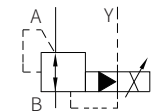

DREM...-6XJ/...YM...

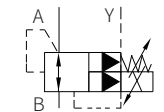

DRE...-6XJ/...Y...

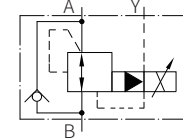

DREM...-6XJ/...Y...

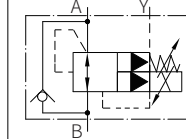

DREE...-6XJ/...YM...

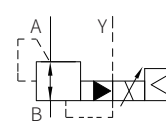

DREME...-6XJ/...YM...

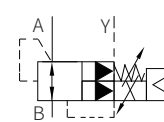

DREE...-6XJ/...Y...

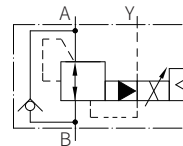

DREME...-6XJ/...Y...

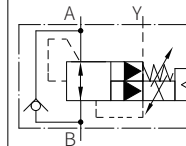



## Technical parameters

| Electronic control unit (OBE) |                   |     |                  |
|-------------------------------|-------------------|-----|------------------|
| Supply voltage                | Nominal voltage   | VDC | 24               |
|                               | Lower limit value | VDC | 21               |
|                               | Upper limit value | VDC | 35               |
| Current consumption           | A                 |     | ≤1.5             |
| Required power                | A                 |     | 2, time interval |
| Input                         | Voltage           | V   | 0 to 10          |
|                               | Current           | mA  | 4 to 20          |
| Output                        | Measuring current | mA  | 1 mV ± 1 mA      |
| Valve protection to EN60529   |                   |     | IP65             |

## Characteristic curve

(Measured when using HLP46,  $\vartheta_{oil} = 40^\circ\text{C} \pm 5^\circ\text{C}$ )

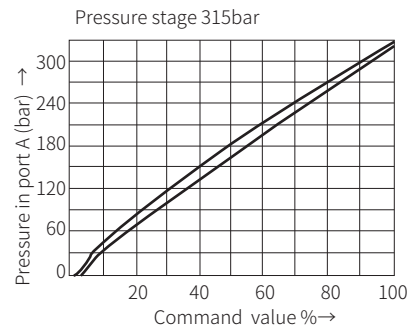
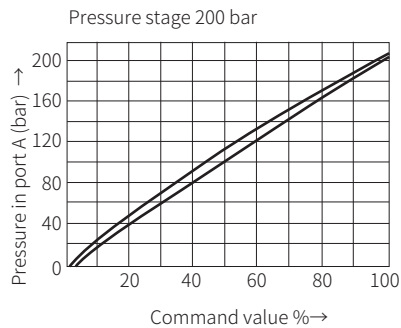
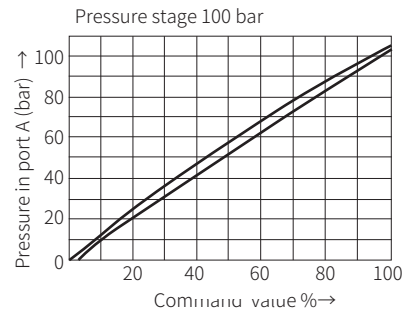
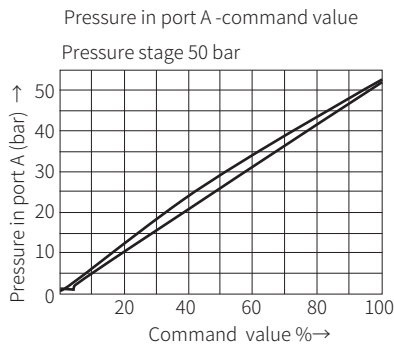

## Characteristic curve

(Measured when using HLP46,  $\vartheta_{oil} = 40^\circ\text{C} \pm 5^\circ\text{C}$ )

Pressure in port A - flow  $q_v$

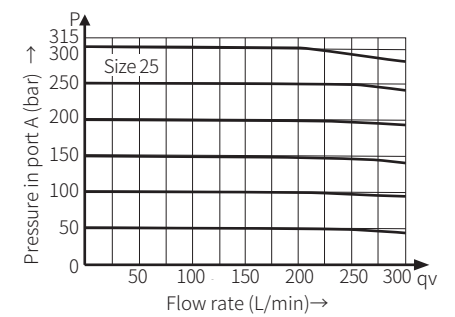
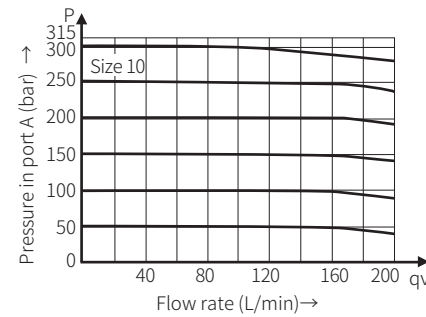

The pressure difference via the check valve from port A to port B

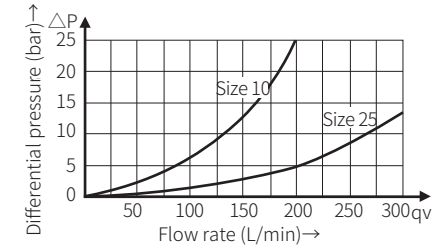

The pressure difference from port B to port A

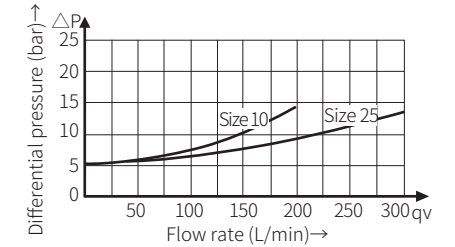

Component size

Size unit: mm

Model DRE(M)

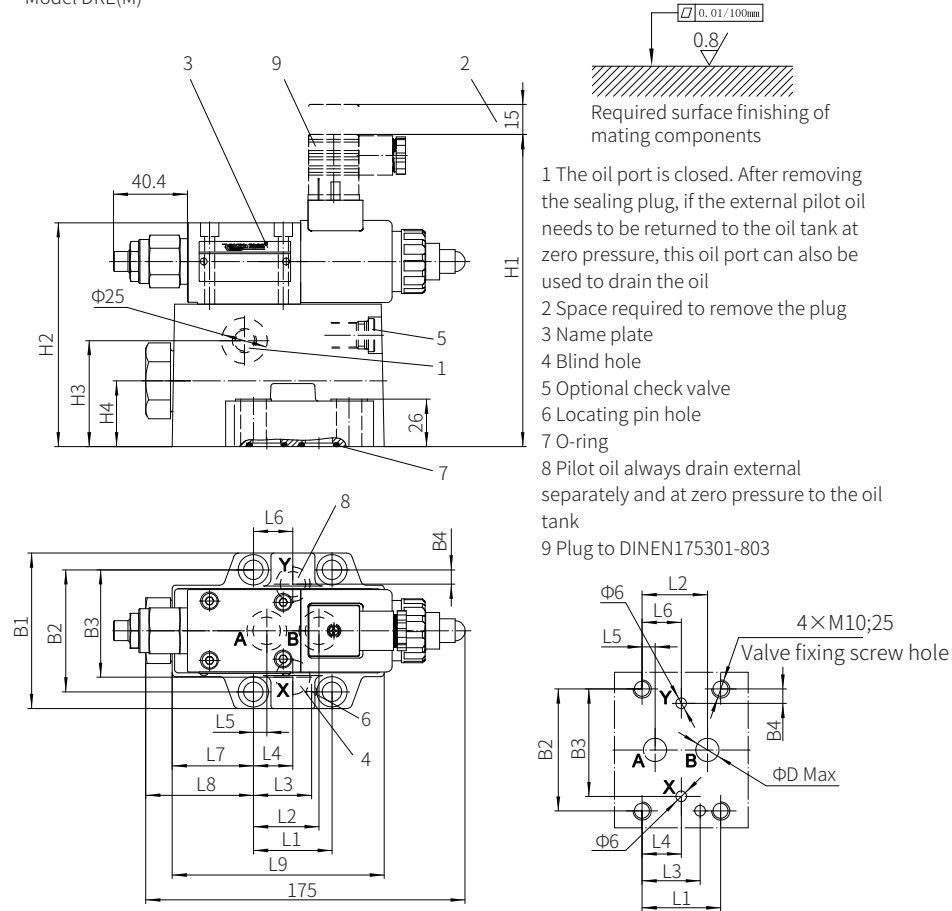

| size | L1   | L2   | L3   | L4   | L5   | L6   | L7   | L8   | L9  |
|------|------|------|------|------|------|------|------|------|-----|
| 10   | 42.9 | 35.8 | 31.8 | 21.5 | 7.2  | 21.5 | 44.5 | 59   | 116 |
| 25   | 60.3 | 49.2 | 44.5 | 20.6 | 11.1 | 39.7 | 27.3 | 41.8 | 116 |

| size | B1  | B2   | B3   | B4  | H1    | H2    | H3 | H4 | D  |
|------|-----|------|------|-----|-------|-------|----|----|----|
| 10   | 85  | 66.7 | 58.8 | 7.9 | 170.8 | 122.5 | 58 | 36 | 13 |
| 25   | 102 | 79.4 | 73   | 6.4 | 184.5 | 136.5 | 64 | 44 | 22 |

Component size

Size unit: mm

Model DRE(M)E

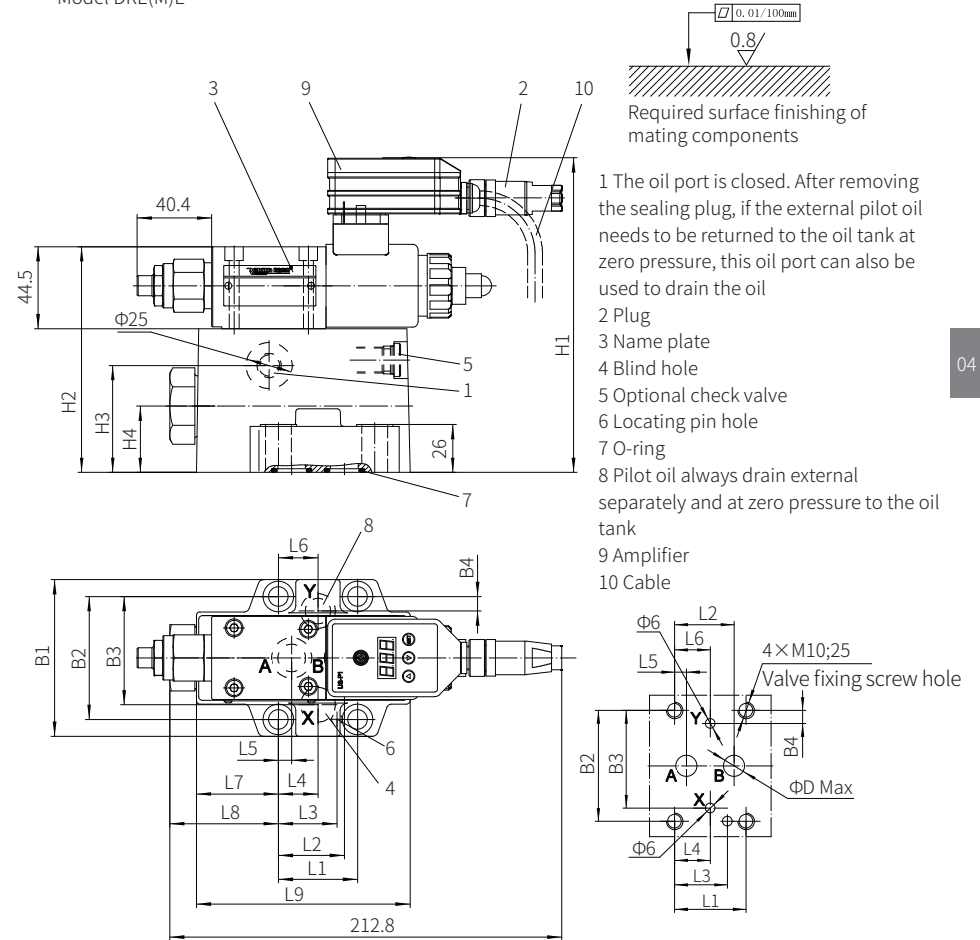

| size | L1   | L2   | L3   | L4   | L5   | L6   | L7   | L8   | L9  |
|------|------|------|------|------|------|------|------|------|-----|
| 10   | 42.9 | 35.8 | 31.8 | 21.5 | 7.2  | 21.5 | 44.5 | 59   | 116 |
| 25   | 60.3 | 49.2 | 44.5 | 20.6 | 11.1 | 39.7 | 27.3 | 41.8 | 116 |

| size | B1  | B2   | B3   | B4  | H1    | H2    | H3 | H4 | D  |
|------|-----|------|------|-----|-------|-------|----|----|----|
| 10   | 85  | 66.7 | 58.8 | 7.9 | 170.8 | 122.5 | 58 | 36 | 13 |
| 25   | 102 | 79.4 | 73   | 6.4 | 184.5 | 136.5 | 64 | 44 | 22 |